

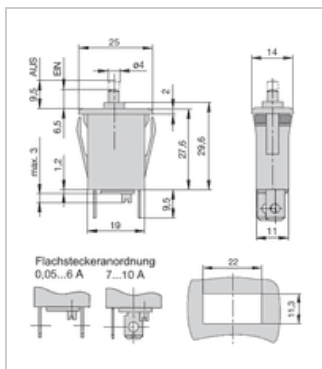

E-T-A circuit breaker 105-P10-7,0 A

Manufacturer:	E-T-A
Type:	105-P10-7,0
Product no.:	105-P10-7.0
Weight:	0.050



■ Details

1-pole thermal over current circuit breaker with snap-on mounting.

■ Properties

- Reliable switching behaviour due to spring-loaded snap mechanism
- Uninfluenceable trip-free mechanism
- Is according to the circuit breaker norm EN 60934 (IEC 60934): R-Typ, TO.

■ Connection

The connection is made with a 6.3 mm flat plug. Please note the arrangement of the flat plug in the dimension sheet: up to 6 A they are parallel arranged, from 7-10 A they are offset 90° as shown in the picture.

■ Replacement for Weber Unimat T11-611 or Kedu RB1-2

Usable as a replacement for Weber Unimat T11-611 (please note the dimensions)

■ Specifications

Nominal current	0.5 - 10.0 A
Nominal voltage	AC 240 V, DC 48 V
Protection class	Operating area IP40, connecting area IP00
Isolation	Reinforced isolation in the actuation element
Ambient temperature	-20..60 °C
Switch-off	Thermal (träge)
Approval	VDE, SEV, Kema (EN 60934), CSA, UL
Installation	Snap-on mounting
Installation dimension	11.3 x 22 mm
Connection	Flat plug 6.3 mm
Circuit breaker norm	EN 60934 (IEC 60934): R-Typ, TO