

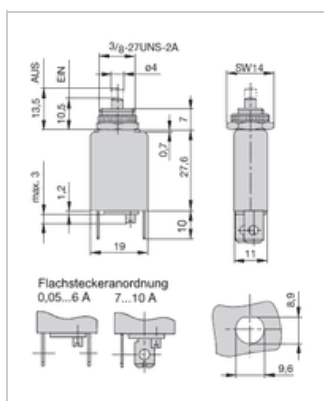

## E-T-A circuit breaker 106-P10-2,0 A

Manufacturer:	E-T-A
Type:	106-P10-2,0A
Product no.:	106-P10-2.0
Weight:	0.050



### ■ Details

1-pole thermal over current circuit breaker with threadneck.

### ■ Properties

- Reliable switching behaviour due to spring-loaded snap mechanism
- Uninfluenceable trip-free mechanism
- Is according to the circuit breaker norm EN 60934 (IEC 60934): R-Typ, TO.

### ■ Connection

The connection is made with a 6.3 mm flat plug. Please note the arrangement of the flat plug in the dimension sheet: up to 6 A they are mounted parallel, from 7-10 A they are offset 90° as shown in the picture.

### ■ Replacement for Weber Unimat T11-211 or Kedu RB2

Usable as a replacement for **Weber Unimat T11-211** (please note the dimensions)

### ■ Specifications

<b>Nominal current</b>	0.5 - 10.0 A
<b>Nominal voltage</b>	AC 240 V, DC 48 V
<b>Protection class</b>	Operating area IP40, connecting area IP00
<b>Isolation</b>	Reinforced isolation in the actuation element
<b>Ambient temperature</b>	-20..60 °C
<b>Switch-off</b>	Thermal (träge)
<b>Approval</b>	VDE, SEV, Kema (EN 60934), CSA, UL
<b>Installation</b>	With threadneck, bore-Ø 9.6 mm
<b>Connection</b>	Flat plug 6.3 mm