

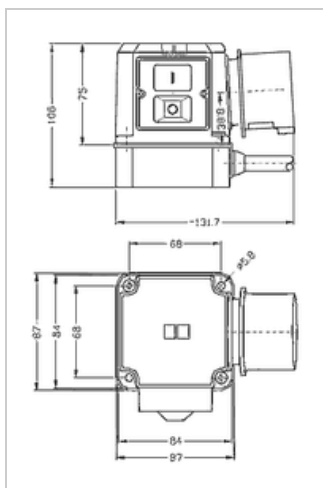

Switch-plug combination K900/B/ST3 with brake, Motor protection 7A

Manufacturer:	Klinger & Born
Type:	K900/B/ST3/KA12/M7.0/Phw/P
Product no.:	SSK850-7A
Weight:	0.800

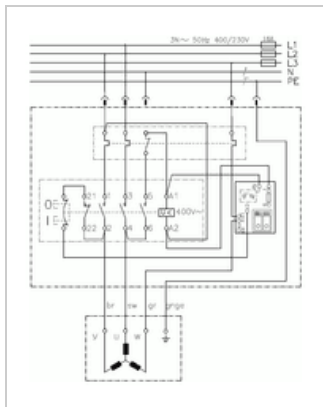

■ Details

Switch-plug combination for three-phase A.C. Current. for circular saws, planing machines, shredders or other machines and motors, which after power failure and power recovery are not allowed to turn back on.

Required for machines for commercial operation, which do not have an engine brake, but are required to have one.

■ Properties

- 3-pole switching. Suitable for mains connection without neutral conductor
- Switching capacity up to 4 kW
- Braking electronics, braking current up to 16 A adjustable
- Motor protection , **Non-adjustable**
- Undervoltage release
- Phase inverter
- Splash water proof cover

■ Suitability

The neutral conductor is not connected.

Not suitable for motors in delta connection, which for example need a voltage of 230V in the terminal box for a electromechanical brake.

If needed a brake can be tapped between a phase and a star point 230V for motors in star connection.

■ Motor protection

The motor protection has to be selected according to the nominal current of the motor (+ ca. 10%). A connection for a thermal contact is not provided, because the motor is better protected with the overcurrent protection.

■ Installation / connection (refer to wiring diagram) / brake

The switch is screwed on the housing base. Grid dimension of the screws: 68 x 68 mm.

The cable outlet is on the side of the housing base, by factory setting on the opposite side of the keypad. by rotating the base, the cable can be routed to all 4 sides.

The brake is by factory setting set to the lowest current. The braking current can be adjusted with a potentiometer.

■ Specifications

Voltage Ue	400 V~
Current Ie	9,0 A
Contactor	KB-04, 400V~
Coil voltage Uc	400V~
Switching capacity	4.0 kW 400V~/AC-3
Braking current	Up to 16 A adjustable
Motor protection	Thermal overcurrent protection
Type of actuation	

Connector	Mechanically on/off
Housing material	CEE 3P+N+E , 16A
Mounting position	Polypropylene PP
Protection class	Any
Connection cable	IP54, splash water proof
Mounting dimensions	1 m H07RN-F G1,5

68 x 68 mm

Alle variants dieses switches: [Schalter-Stecker-Kombination K900/B/ST3 mit Bremse, Motorschutz](#)